

Lillian 34 5X4

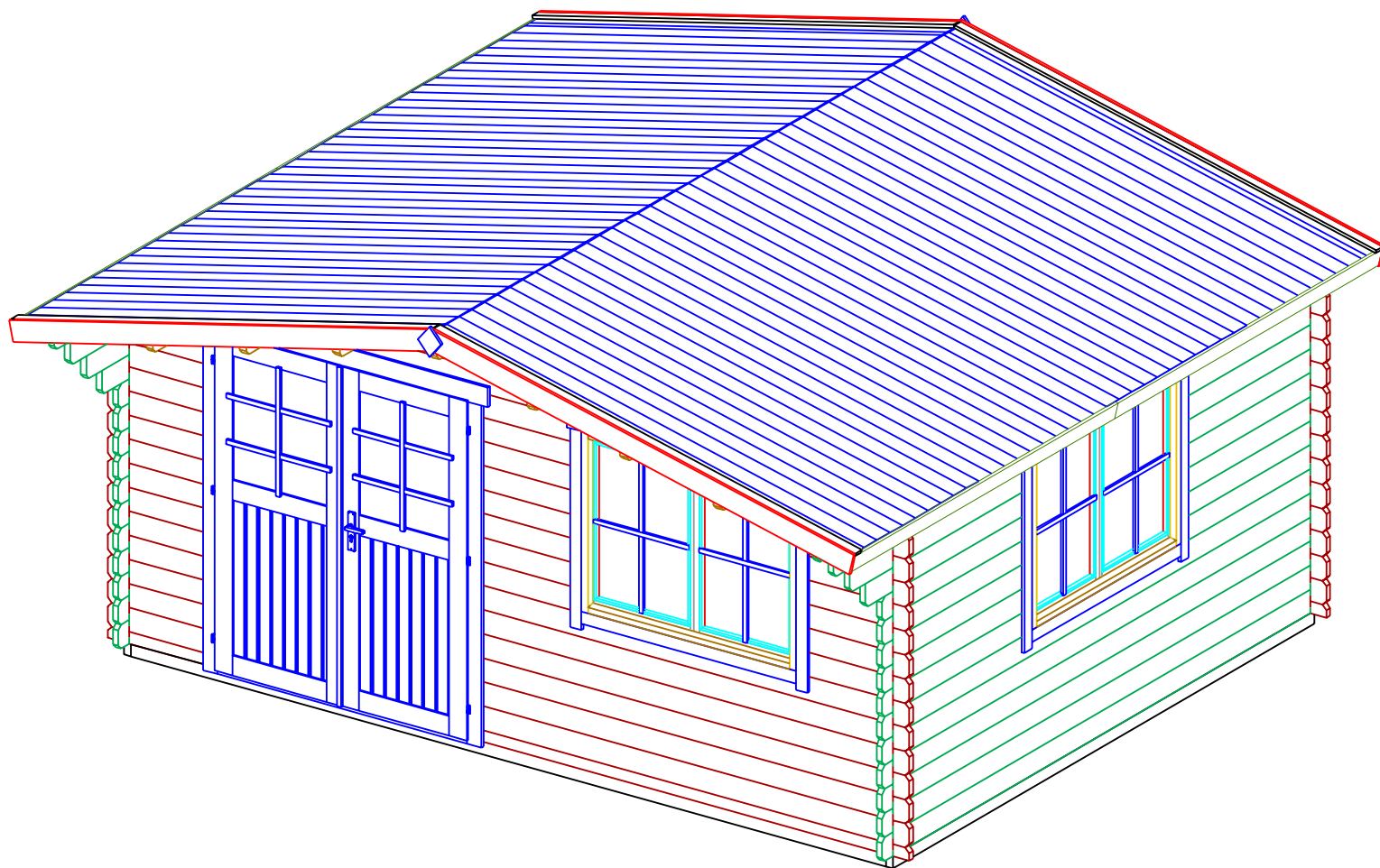

Lillian 34 5X4

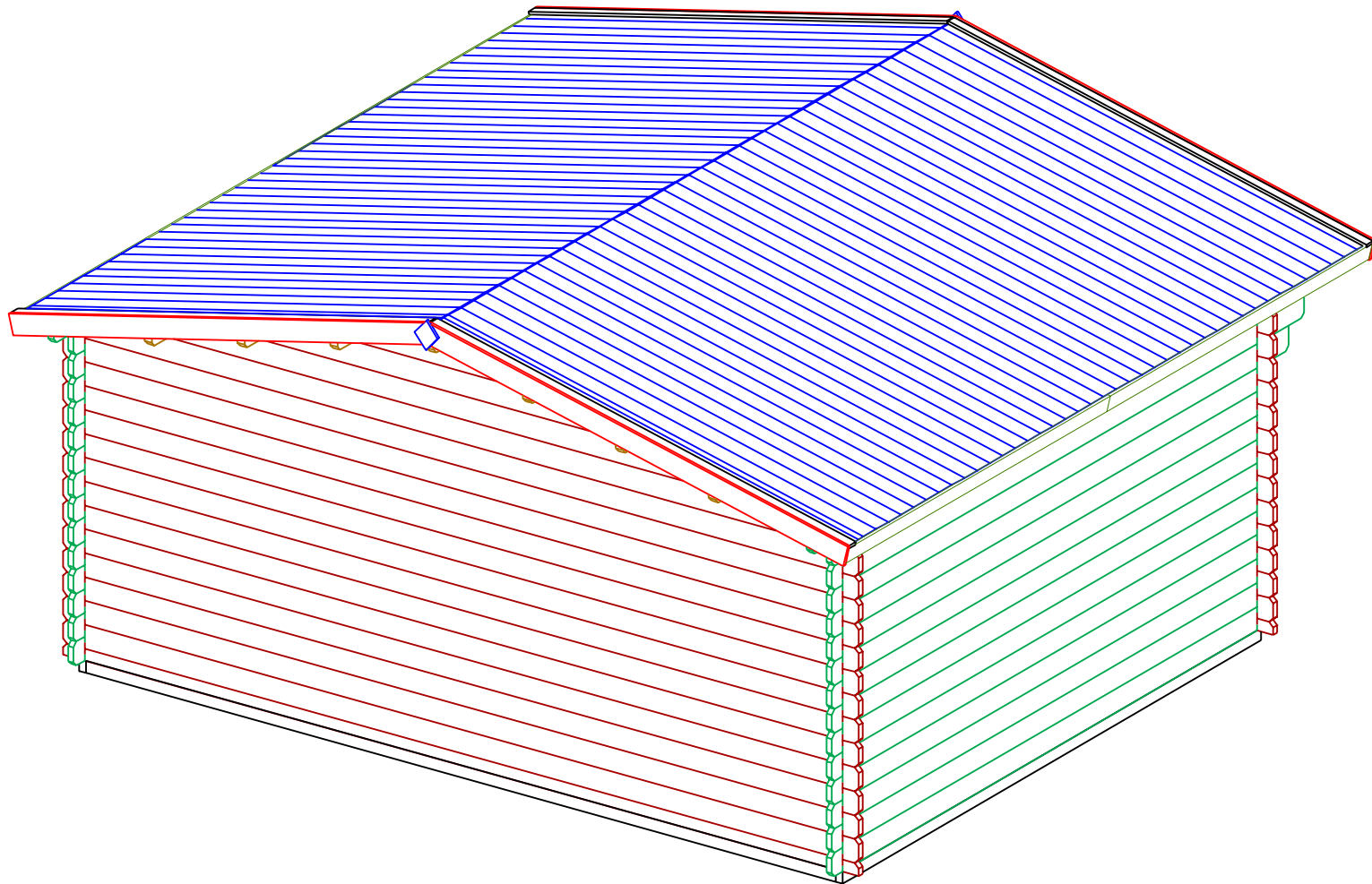

STAGE 1

Lillian 34 5X4



STAGE 2

Lillian 34 5X4

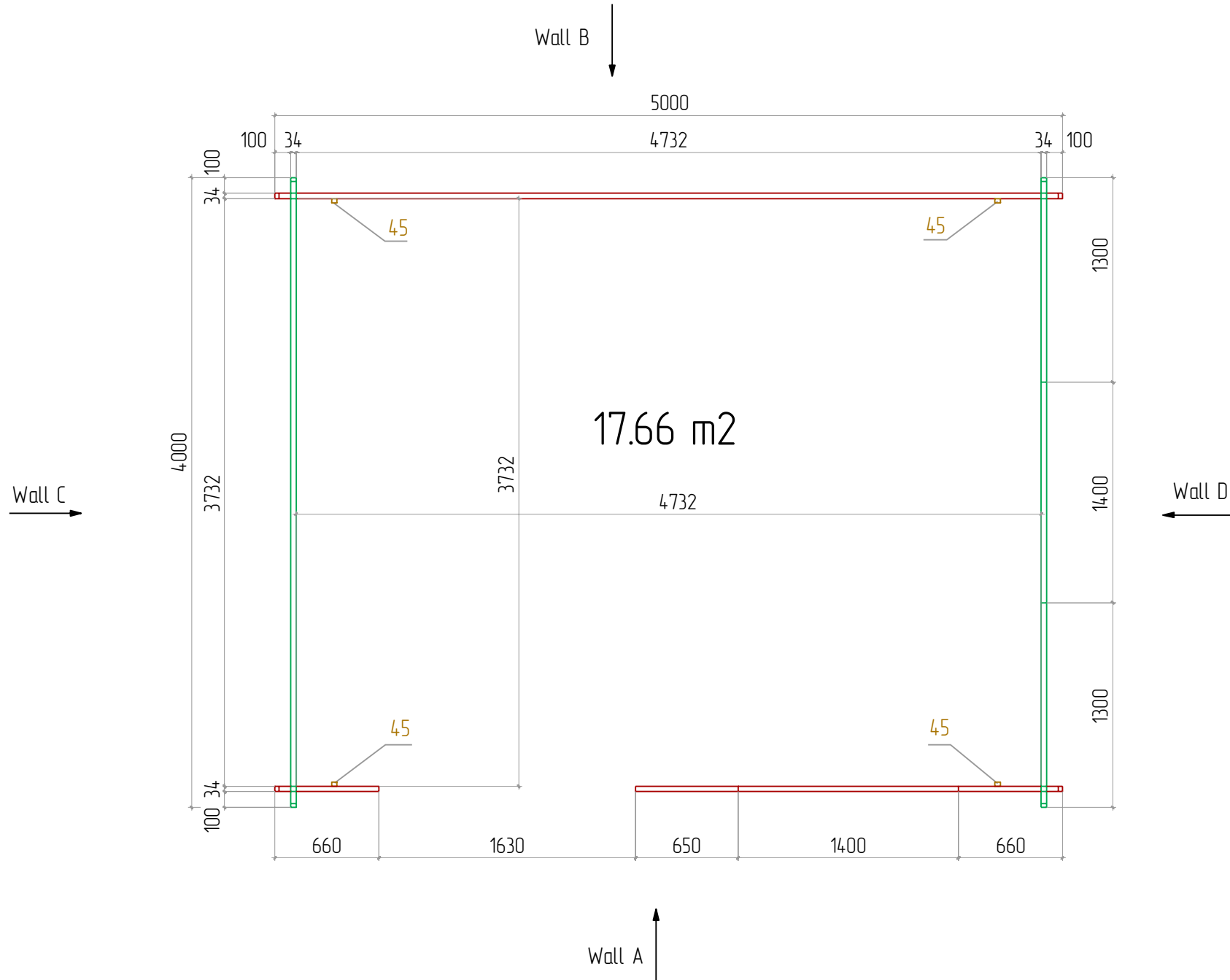

STAGE 2

W-A

Lillian 34 5X4

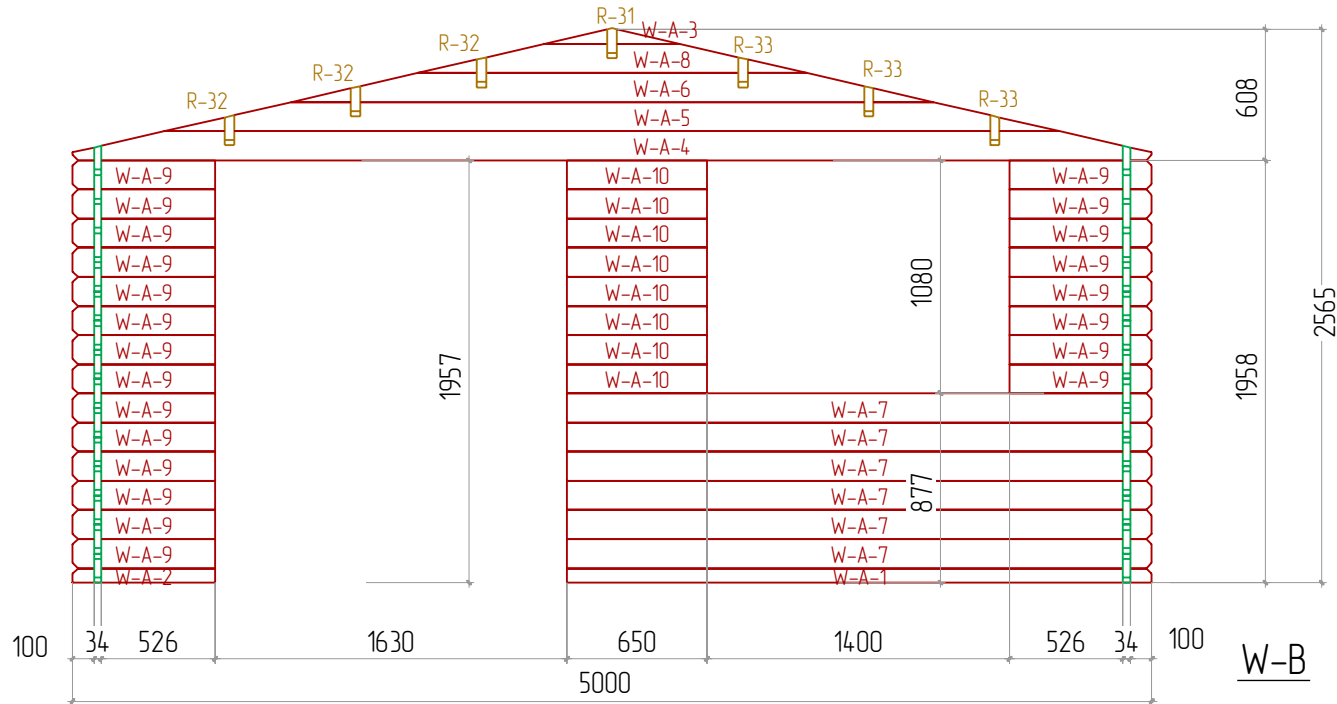

W-B

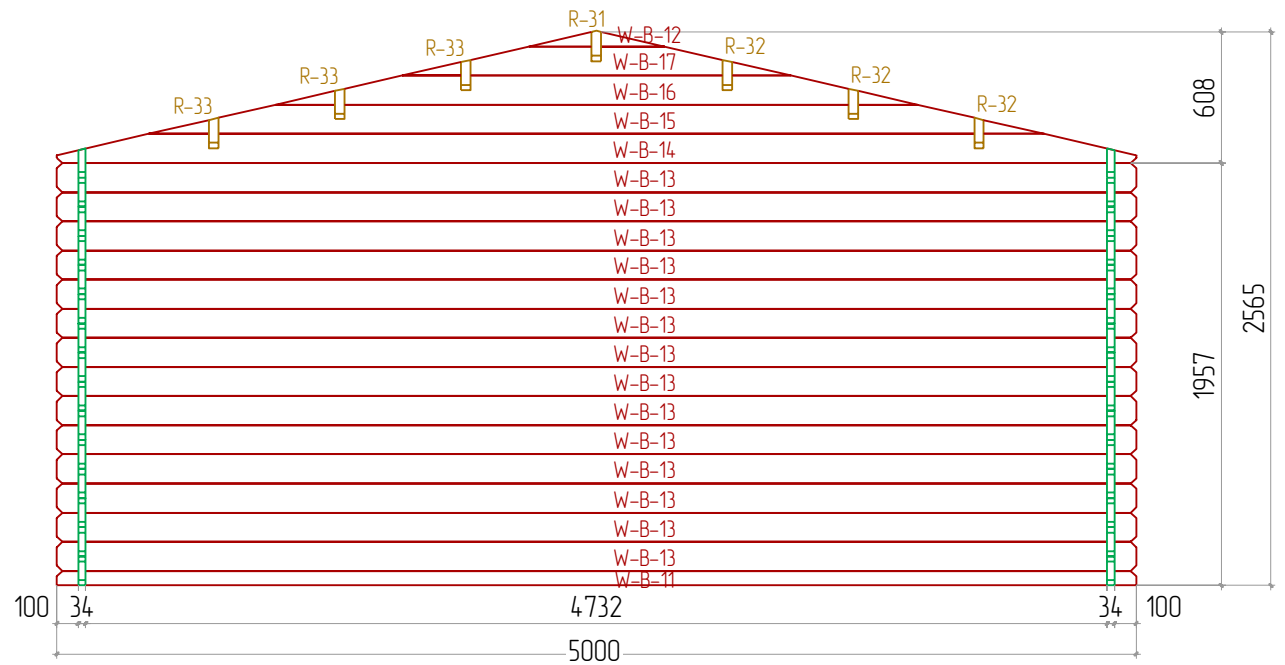

STAGE 2

Lillian 34 5X4

W-C

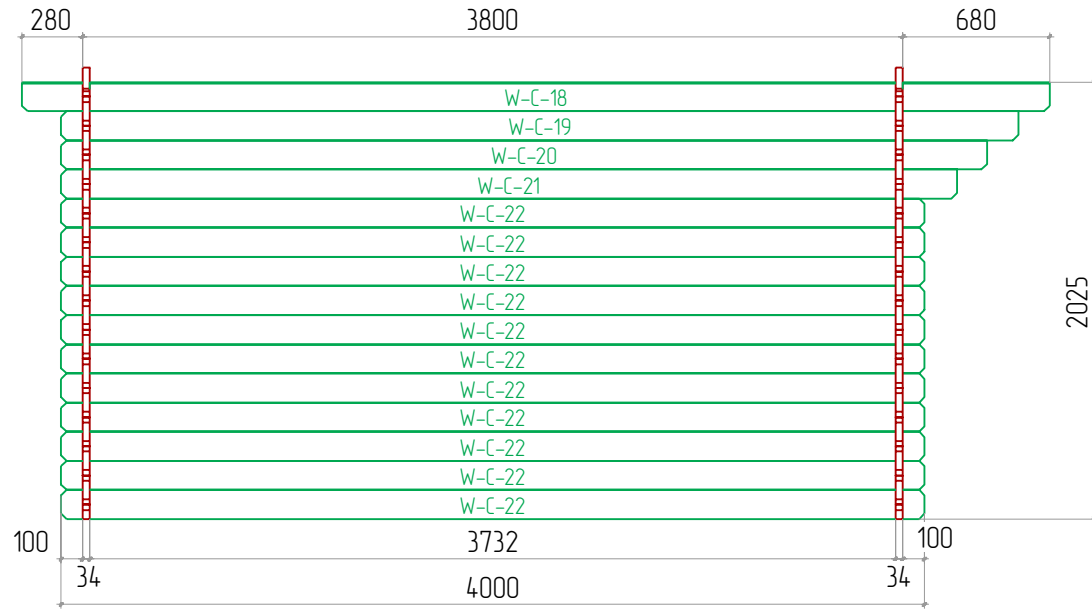

W-D

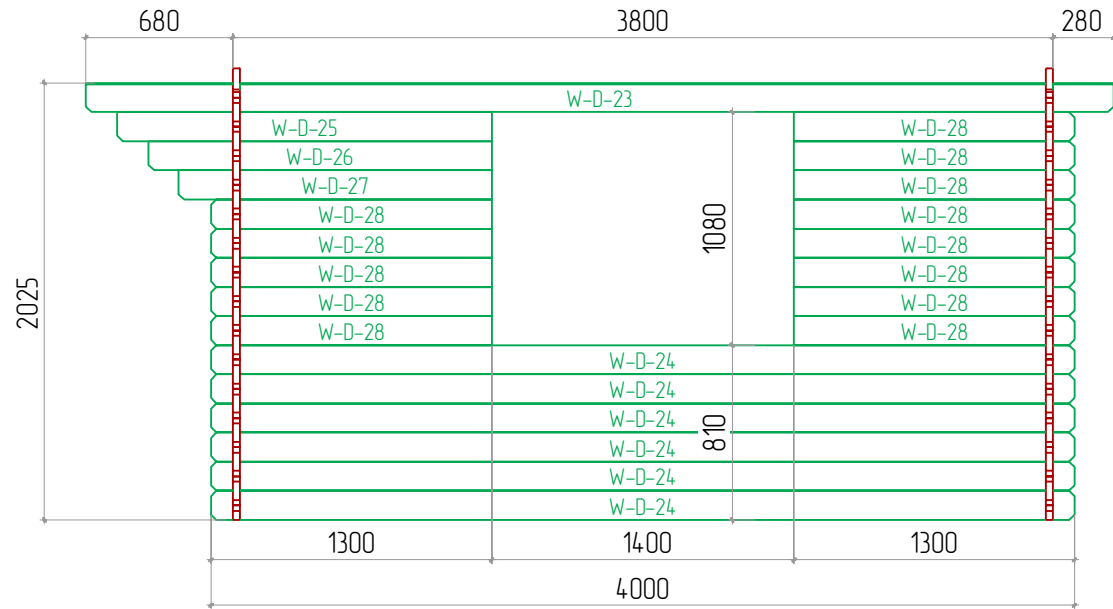

STAGE 3

Lillian 34 5X4

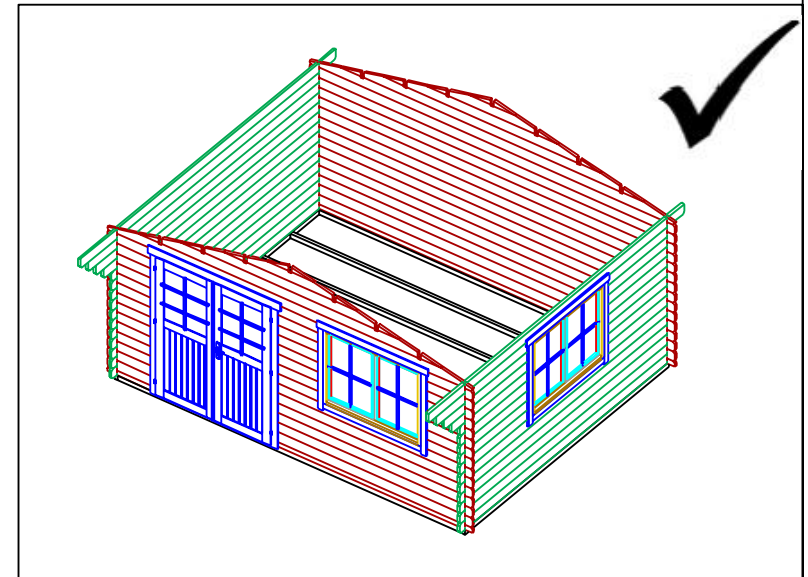
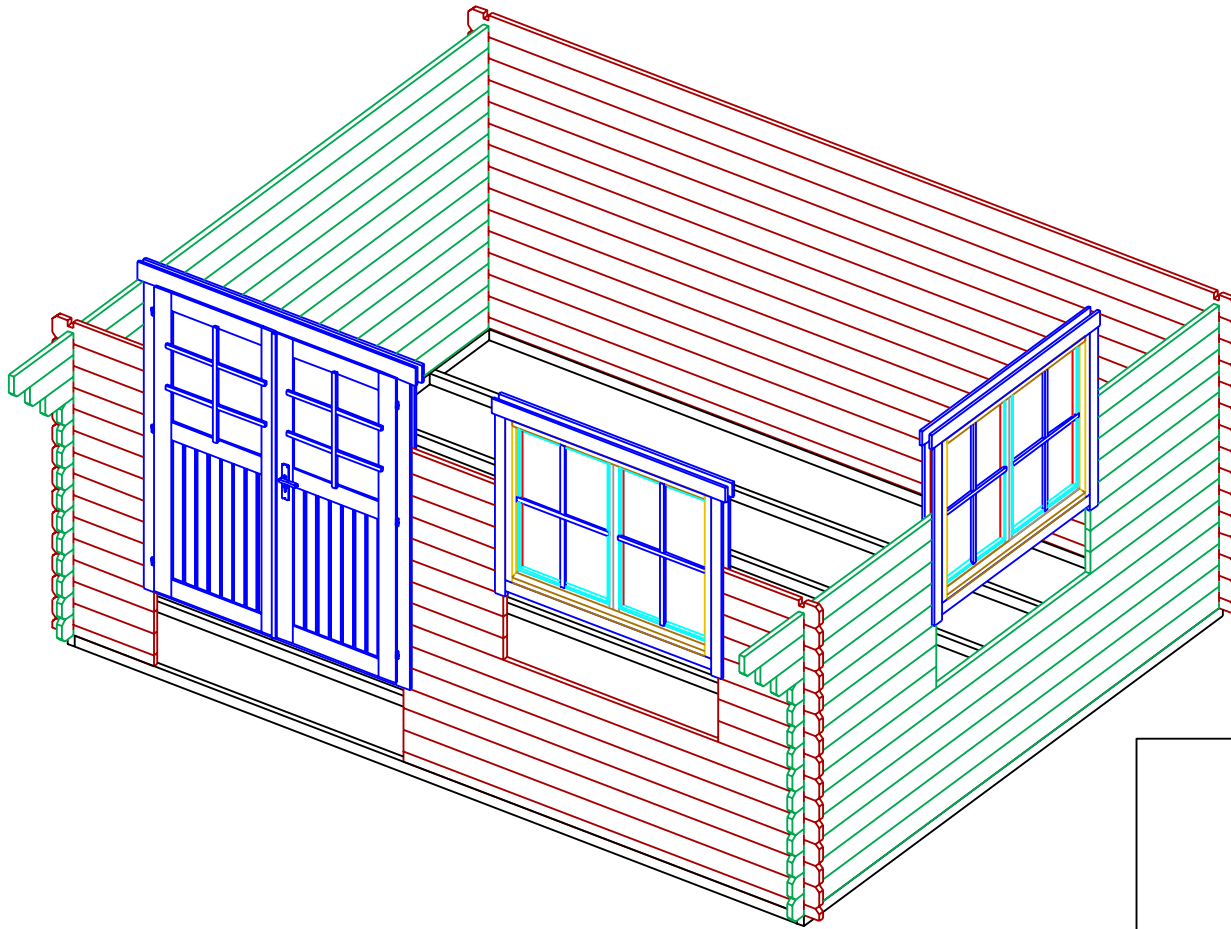

STAGE 4

Lillian 34 5X4

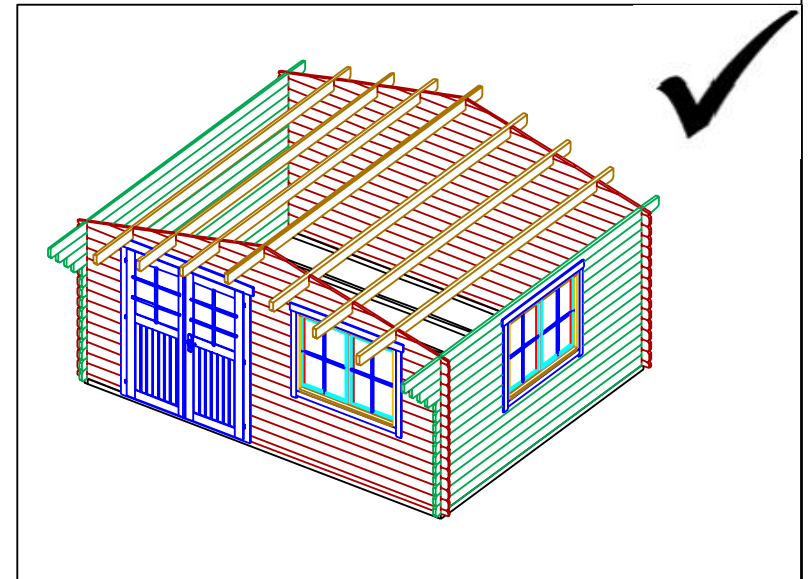
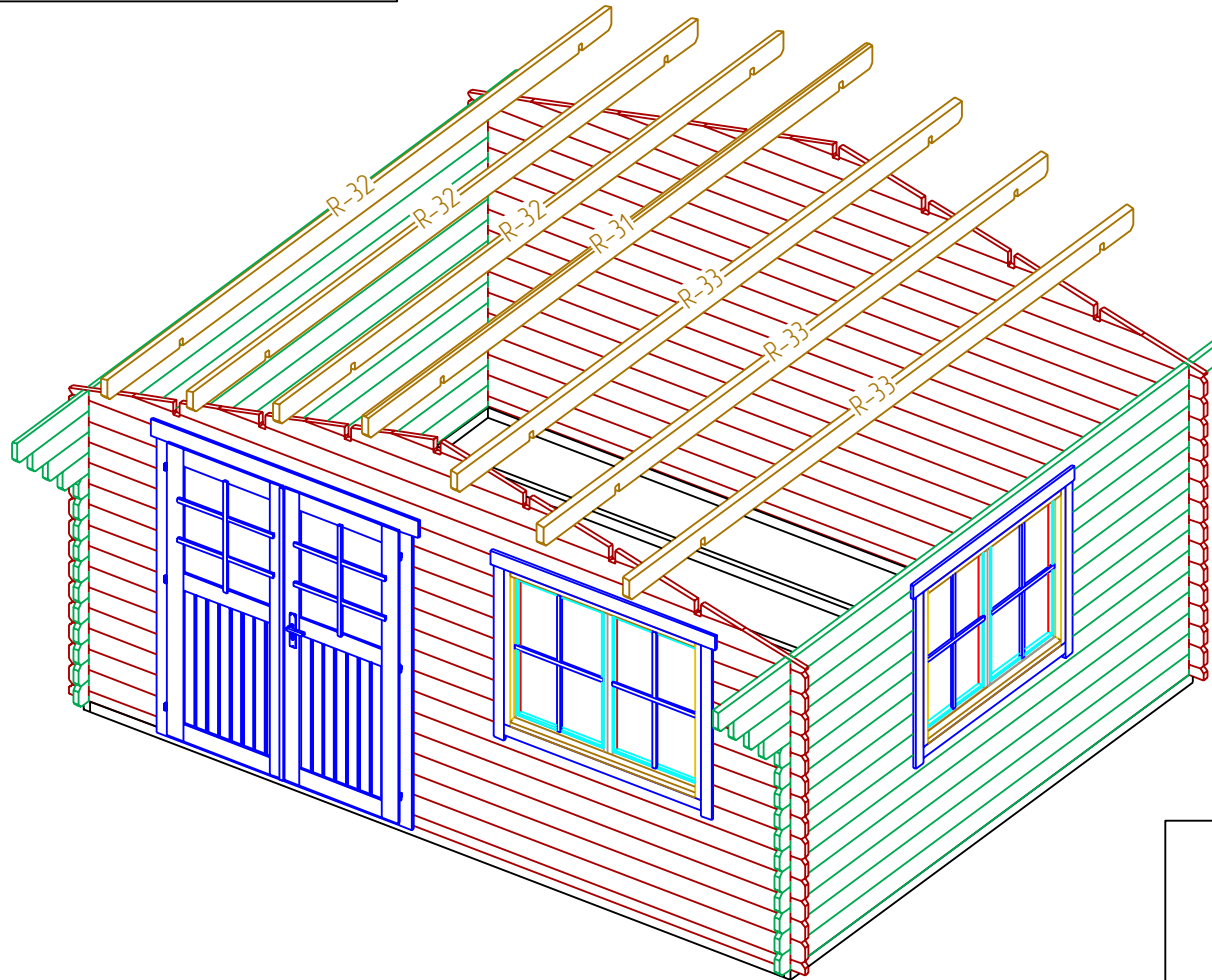

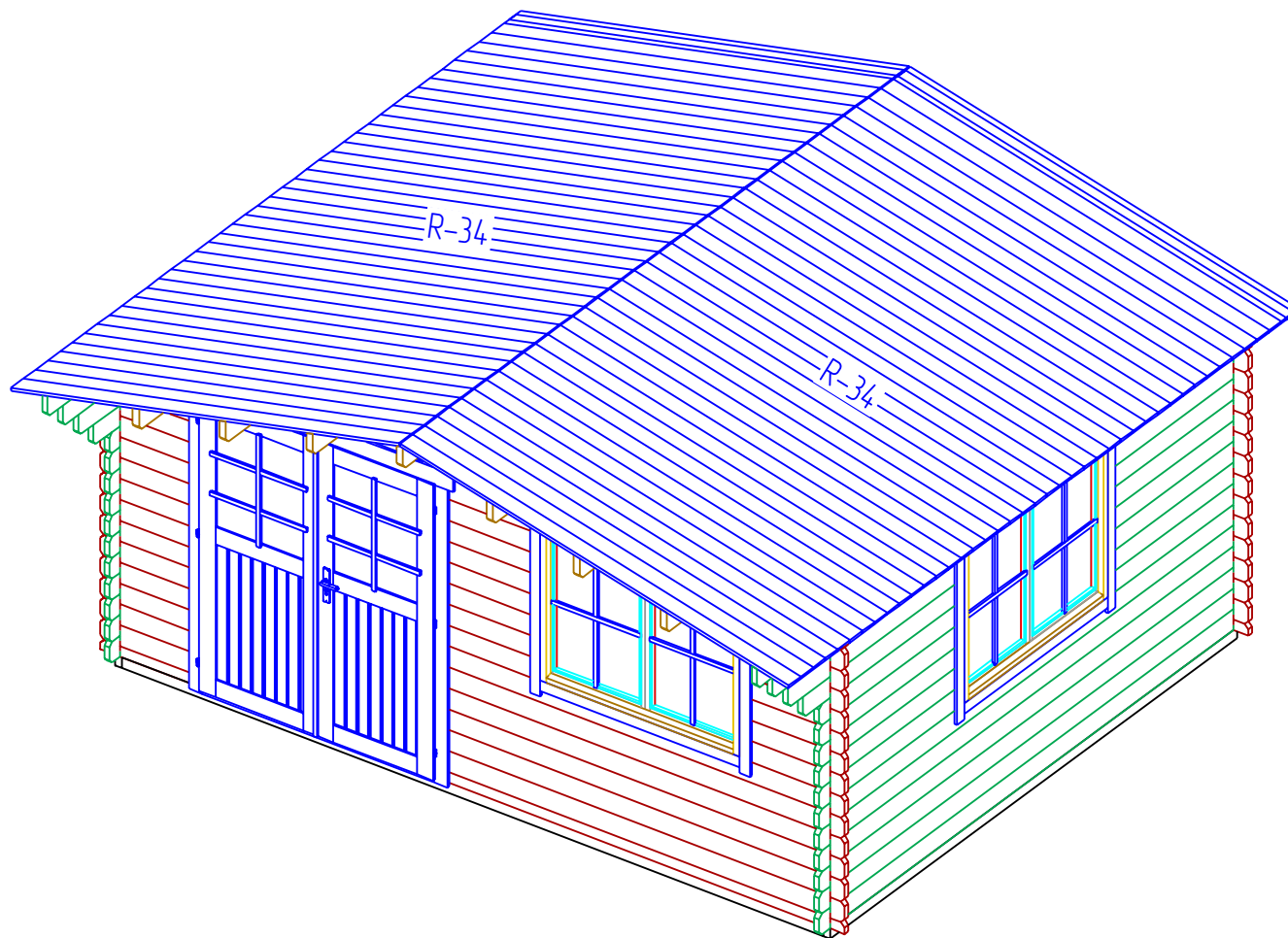

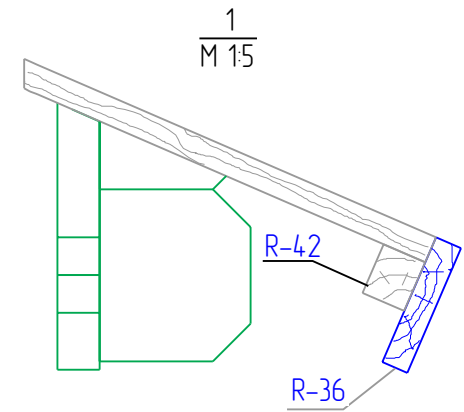
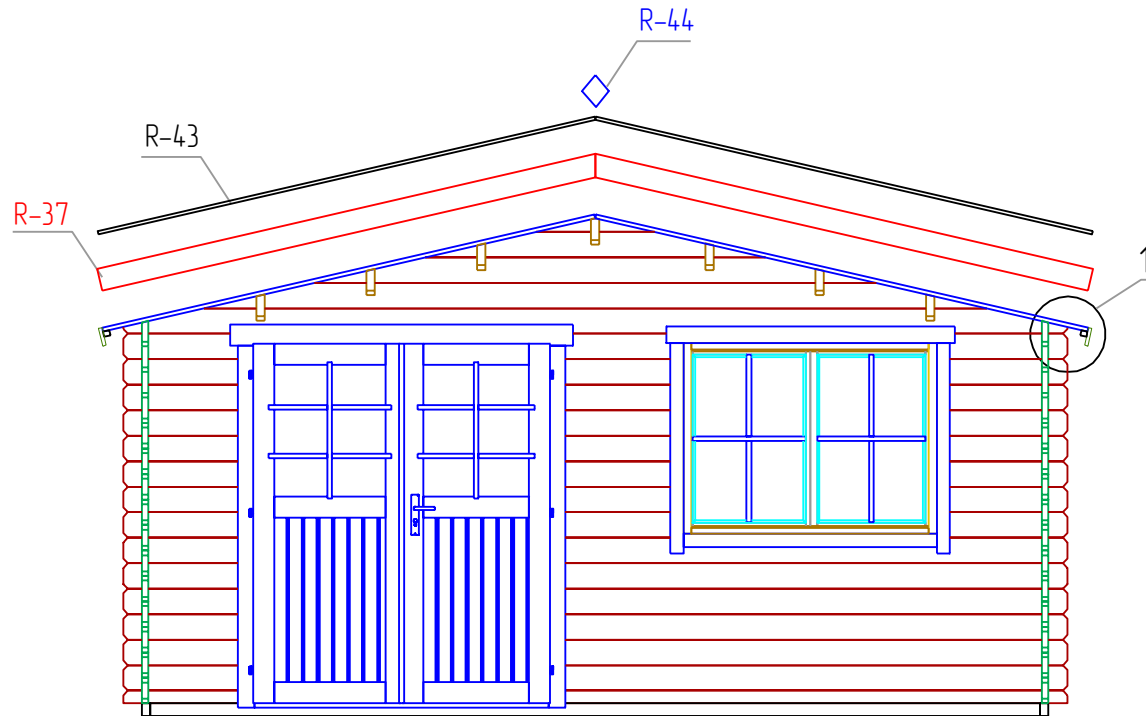

STAGE 6

Lillian 34 5X4

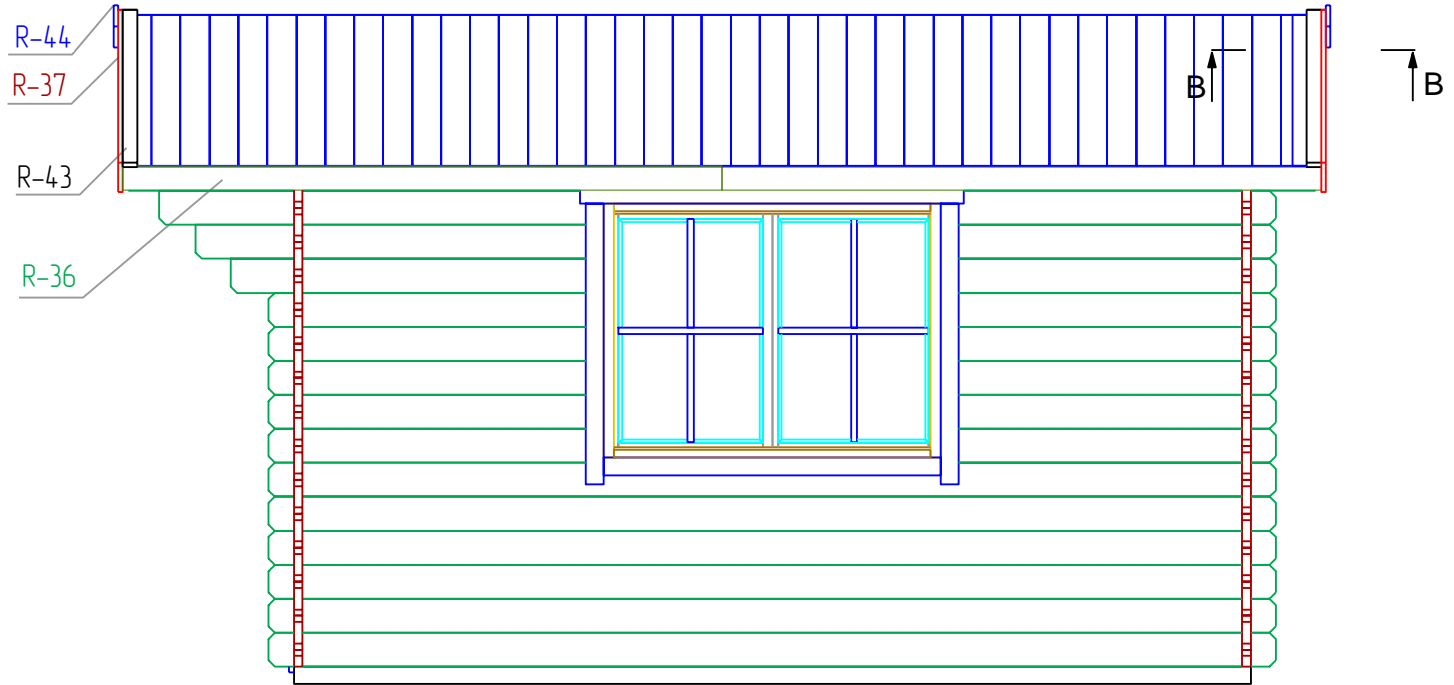

B-B
M 15

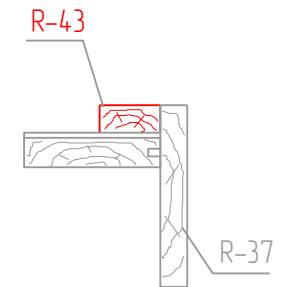

STAGE 7

Lillian 34 5X4

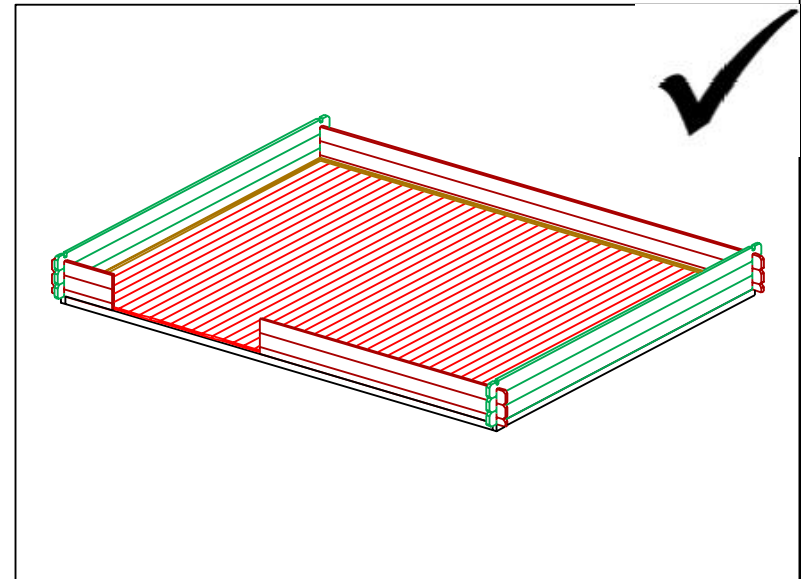
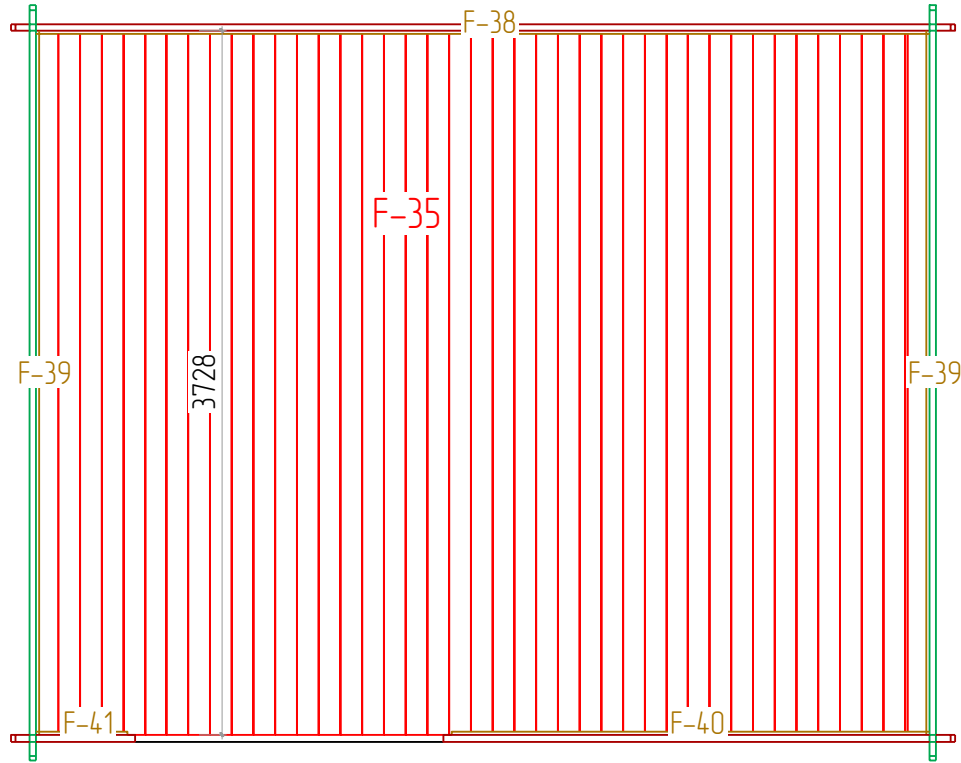

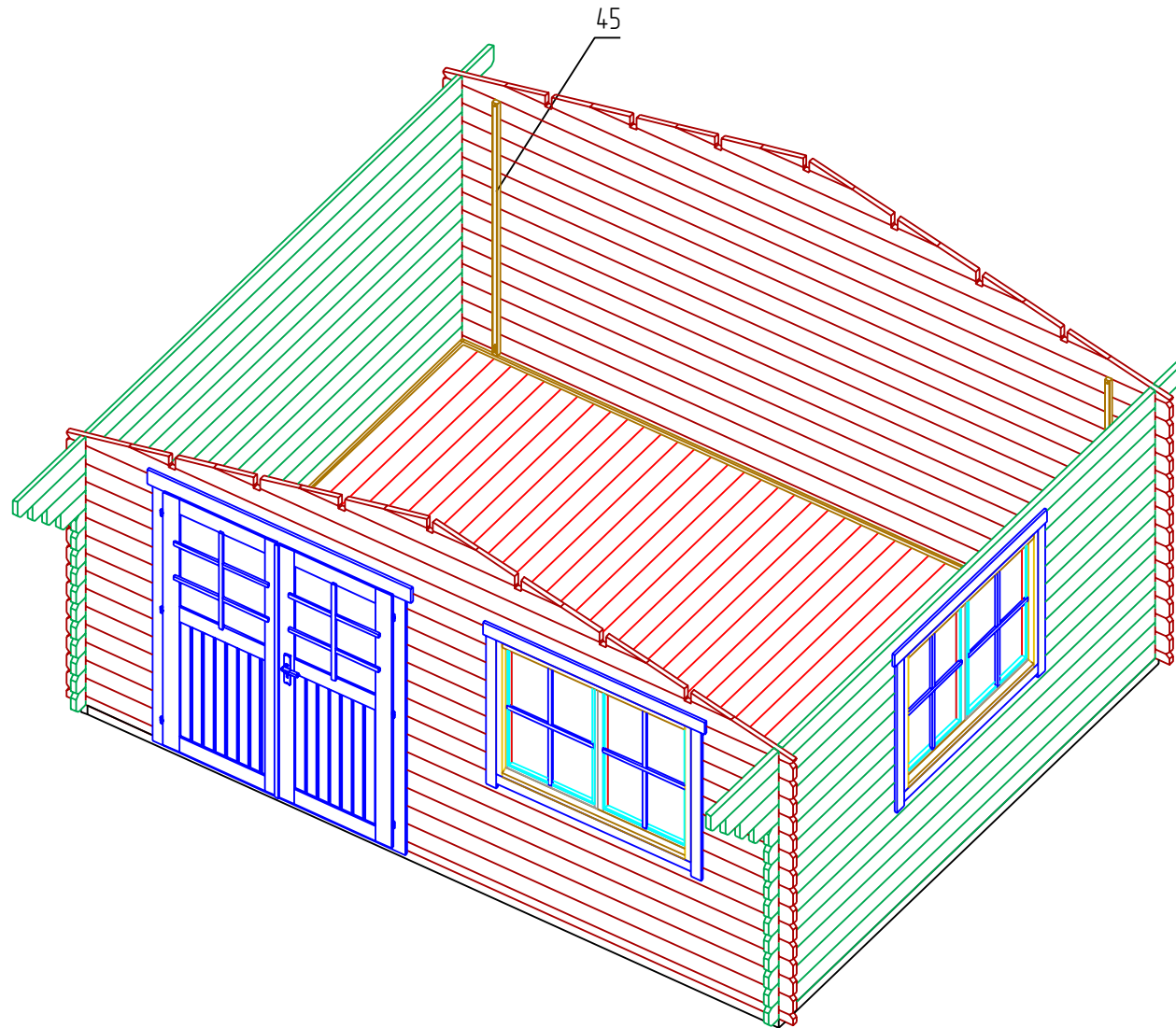

STAGE 1

F
 NR: 29
 PSC: 8
 B/H: 44mm/68mm
 L: 4712mm



F
 NR: 30
 PSC: 2
 B/H: 44mm/68mm
 L: 3800mm

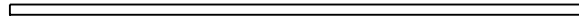

STAGE 2

W
 NR: A 1
 PSC: 1
 B/H: 34mm/68mm
 L: 2710mm



W
 NR: A 2
 PSC: 1
 B/H: 34mm/68mm
 L: 660mm

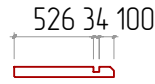

W
 NR: A 7
 PSC: 6
 B/H: 34mm/135mm
 L: 2710mm



W
 NR: A 9
 PSC: 22
 B/H: 34mm/135mm
 L: 660mm

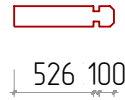

W
 NR: A 10
 PSC: 8
 B/H: 34mm/135mm
 L: 650mm



W
 NR: B 11
 PSC: 1
 B/H: 34mm/68mm
 L: 5000mm



W
 NR: B 13
 PSC: 15
 B/H: 34mm/135mm
 L: 5000mm

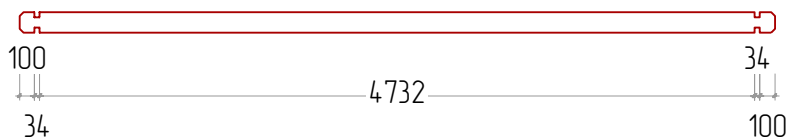



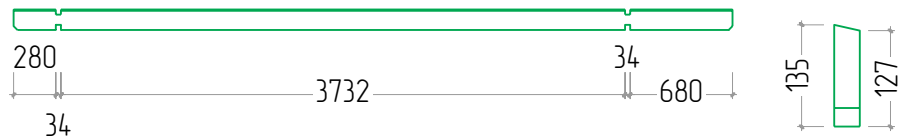





W
 NR: C 18
 PSC: 1
 B/H: 34mm/135mm
 L: 4760mm











Lillian 34 5X4

<p>W NR: C 19 PSC: 1 B/H: 34mm/135mm L: 4435mm</p>	
<p>W NR: C 20 PSC: 1 B/H: 34mm/135mm L: 4290mm</p>	
<p>W NR: C 21 PSC: 1 B/H: 34mm/135mm L: 4150mm</p>	
<p>W NR: C 22 PSC: 11 B/H: 34mm/135mm L: 4000mm</p>	
<p>W NR: D 23 PSC: 1 B/H: 34mm/135mm L: 4760mm</p>	
<p>W NR: D 24 PSC: 6 B/H: 34mm/135mm L: 4000mm</p>	
<p>W NR: D 25 PSC: 1 B/H: 34mm/135mm L: 1735mm</p>	
<p>W NR: D 26 PSC: 1 B/H: 34mm/135mm L: 1590mm</p>	
<p>W NR: D 27 PSC: 1 B/H: 34mm/135mm L: 1450mm</p>	
<p>W NR: D 28 PSC: 13 B/H: 34mm/135mm L: 1300mm</p>	

Lillian 34 5X4

<p>W NR: A PSC: 1</p>	
<p>W NR: B PSC: 1</p>	
<h2>STAGE 3</h2>	
<p>Door PSC: 1 B/H: 1630mm/1958mm</p>	
<p>Window PSC: 2 B/H: 1400mm/1080mm</p>	
<h2>STAGE 4</h2>	
<p>R NR: 31 PSC: 1 B/H: 44mm/140mm L: 4760mm</p>	
<p>R NR: 32 PSC: 3 B/H: 44mm/140mm L: 4760mm</p>	
<p>R NR: 33 PSC: 3 B/H: 44mm/140mm L: 4760mm</p>	
<h2>STAGE 5</h2>	
<p>R NR: 34 PSC: 85 B/H: 20mm/115mm L: 2675mm</p>	
<h2>STAGE 6</h2>	
<p>R NR: 36 PSC: 4 B/H: 18mm/95mm L: 2380mm</p>	
<p>R NR: 37 PSC: 4 B/H: 18mm/120mm L: 2705mm</p>	

R NR: 42 PSC: 4 B/H: 28mm/34mm L: 2380mm	
R NR: 43 PSC: 4 B/H: 18mm/58mm L: 2699mm	
R NR: 44 PSC: 2 B/H: 18mm/120mm L: 120mm	
STAGE 7	
F NR: 35 PSC: 43 B/H: 20mm/115mm L: 3728mm	
F NR: 38 PSC: 1 B/H: 18mm/20mm L: 4732mm	
F NR: 40 PSC: 1 B/H: 18mm/20mm L: 2533mm	
F NR: 41 PSC: 1 B/H: 18mm/20mm L: 483mm	
F NR: 39 PSC: 2 B/H: 18mm/20mm L: 3732mm	
STAGE 8	
NR: 45 PSC: 4 B/H: 28mm/34mm L: 1900mm	

W-A

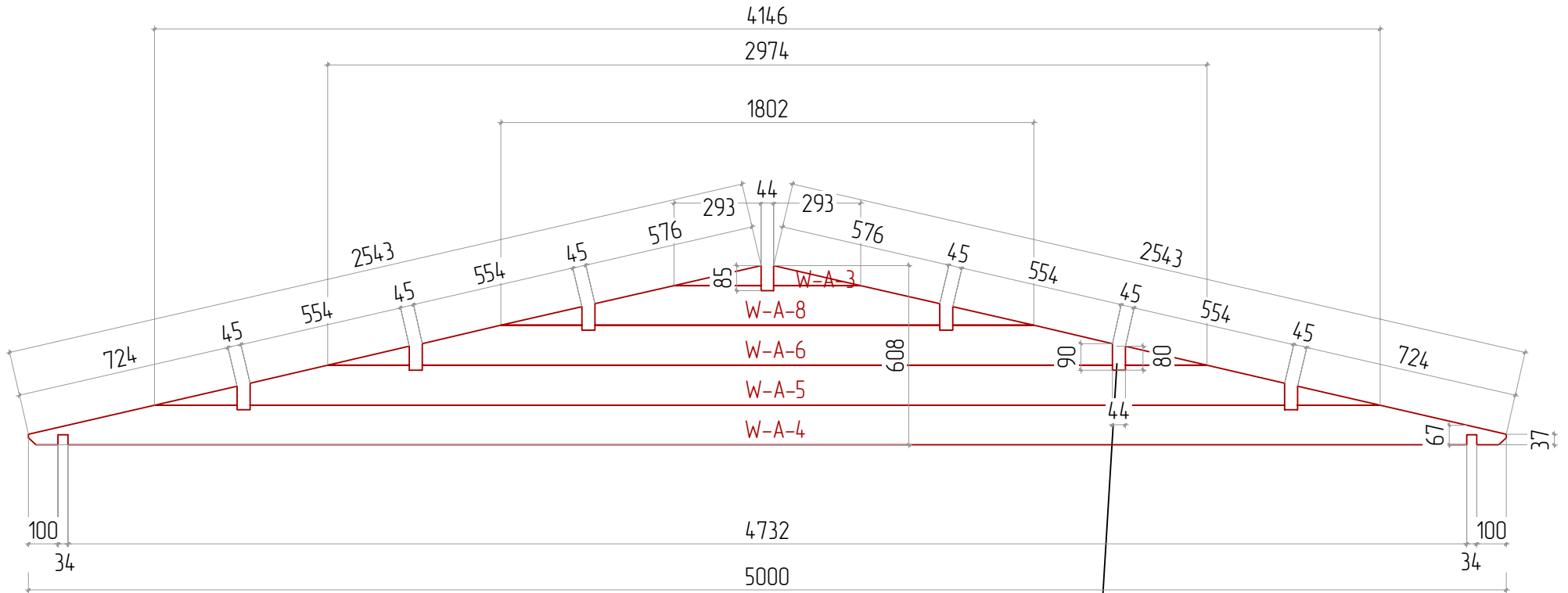

W-B

