

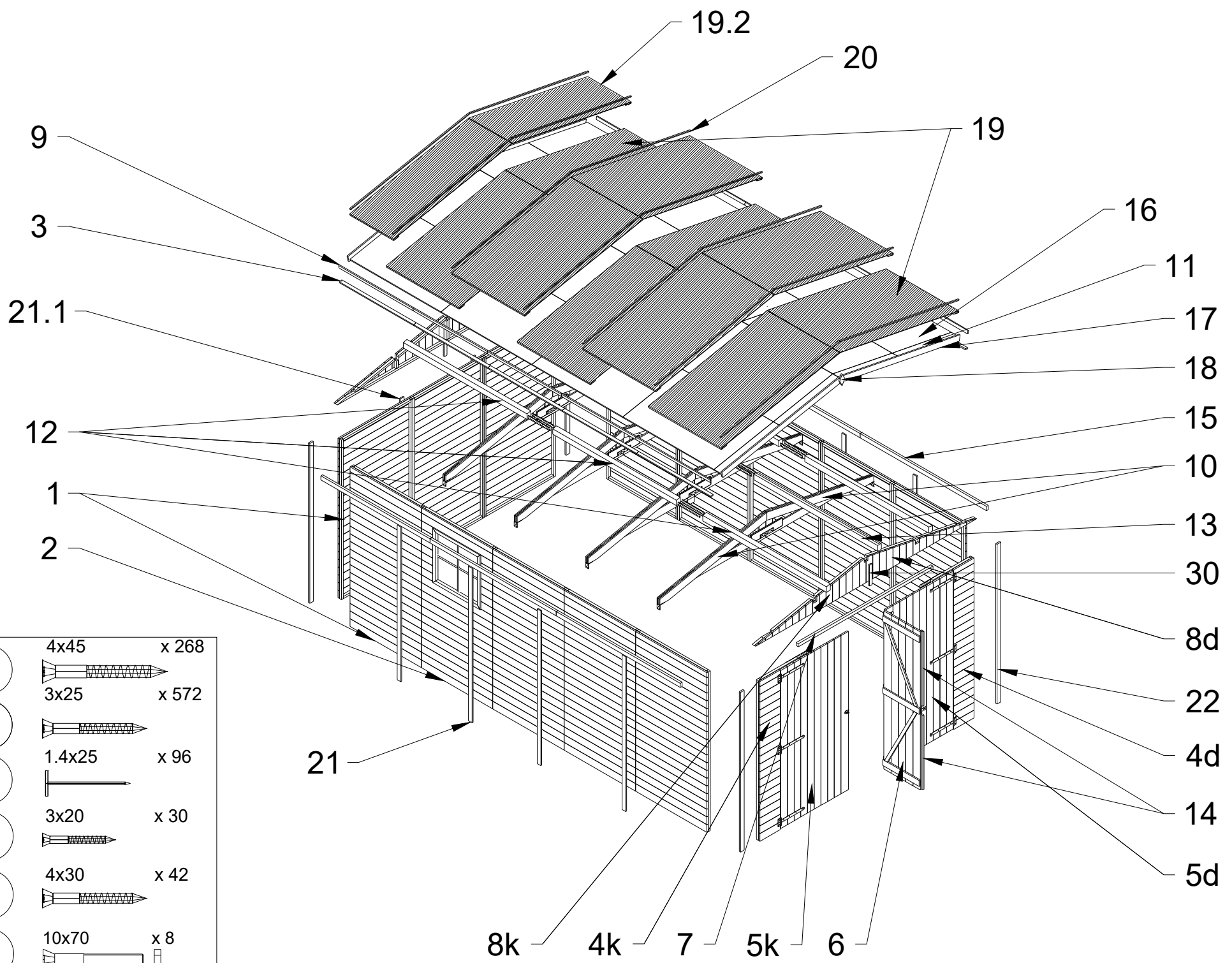

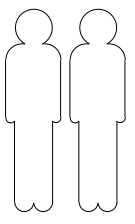

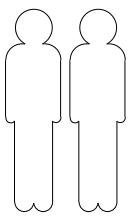





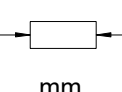
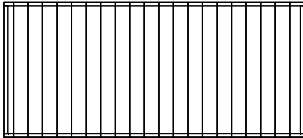
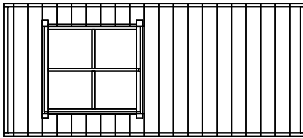

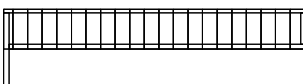
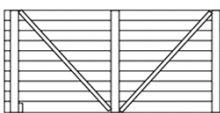
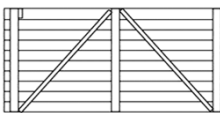

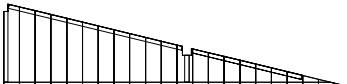
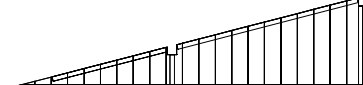
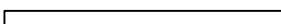
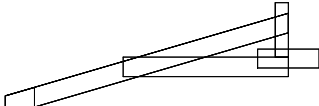
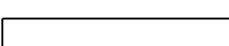
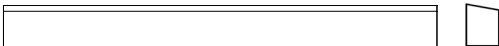
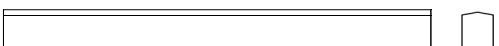
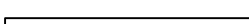

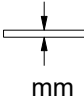
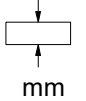
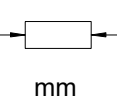
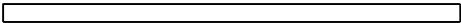
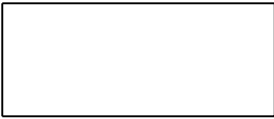
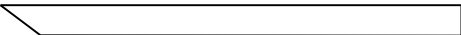
M101

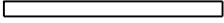
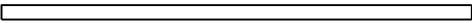
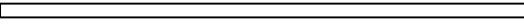
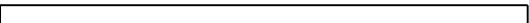
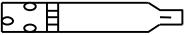

- | | | | |
|--|-----|--------|-------|
|  | (A) | 4x45 | x 268 |
| | (B) | 3x25 | x 572 |
| | (C) | 1.4x25 | x 96 |
| | (D) | 3x20 | x 30 |
| | (E) | 4x30 | x 42 |
| | (F) | 10x70 | x 8 |

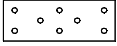

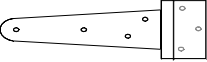
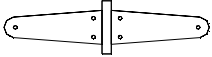
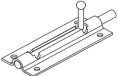
№		PCS	 mm	 mm	 mm
1		11		980	1900
2		2		980	1900
3		10	OSB	35	1020
4k		1		280	1900
4d		1		280	1900
5k		1		930	1880
5d		1		930	1880
6		1		500	1880
7		1	30	60	1850
8k		2		300	1517
8d		2		300	1517
9		10	15	35	1020
10		8		363	1470
11		4	OSB	100	830
12		6	40	60	1700
13		3	40	60	1700
14		2	15	35	920

№		PCS	 mm	 mm	 mm
15		6	17	47	1700
16		16	OSB	830	1250
17		4	15	69	1700
18		2	15	75	145
19		5		1 m	3,47m
19.2		1		0,5m	3,47m
20		28	15	35	813
21		8	15	35	1835
21.1		2	15	35	1900
22		4	17	47	1900
23		1			
24		20			
25		9			
26		14			
27		6			
28		3			
29		2			
30		2	15	35	240

1

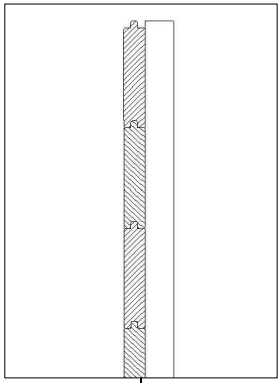

2

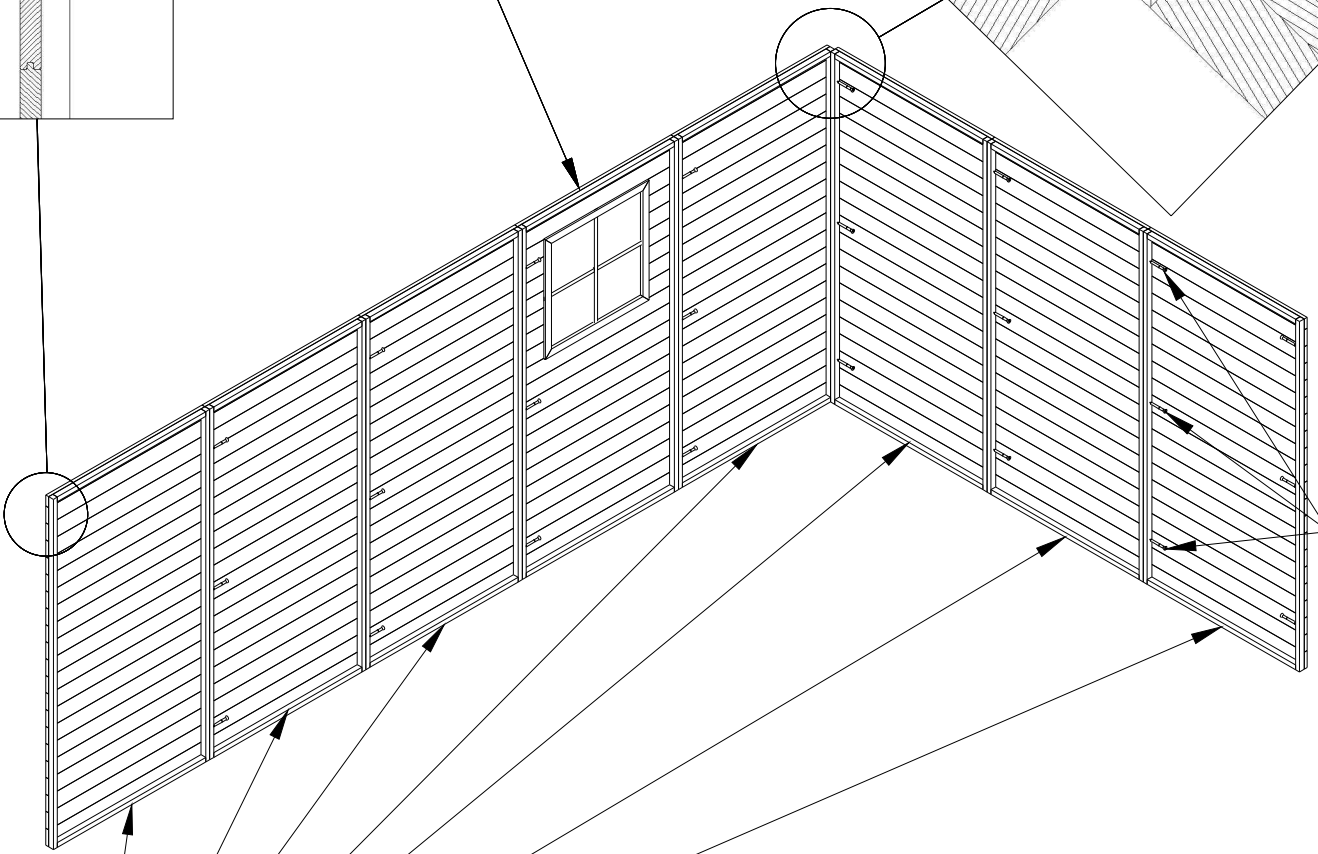
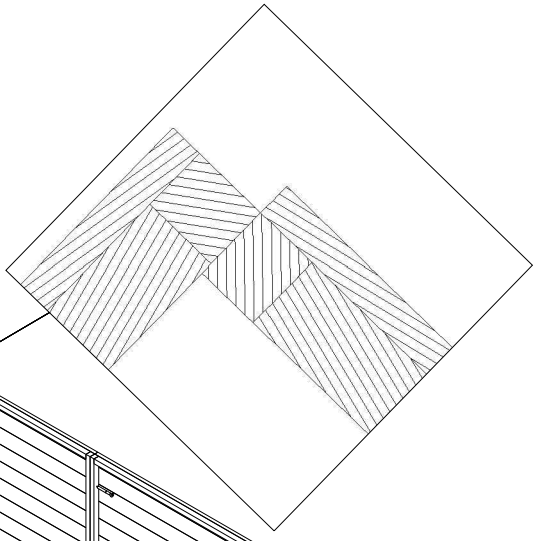

A x24

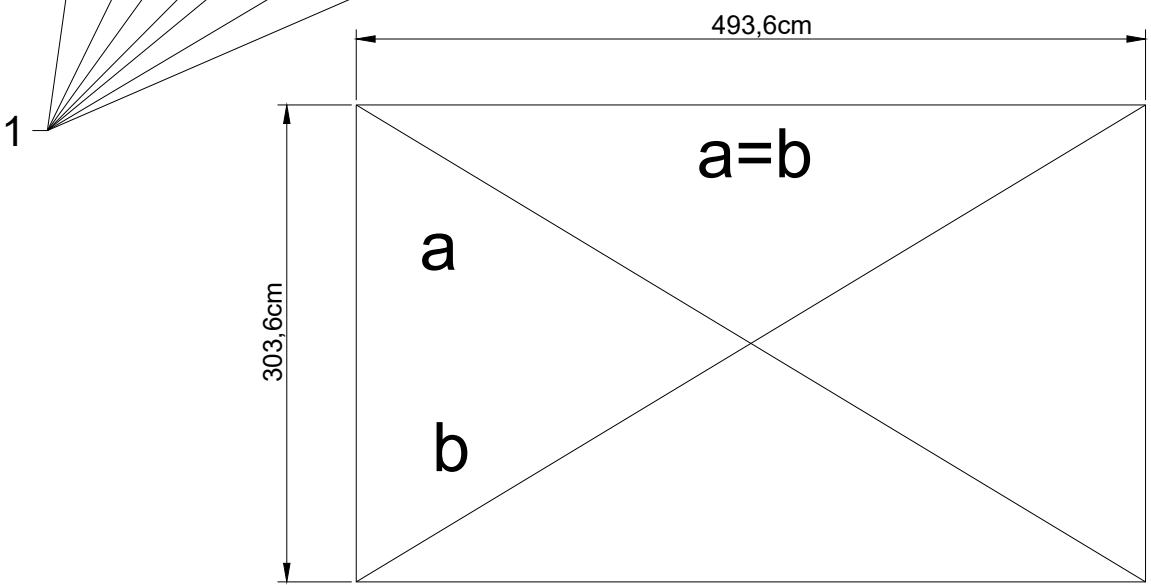

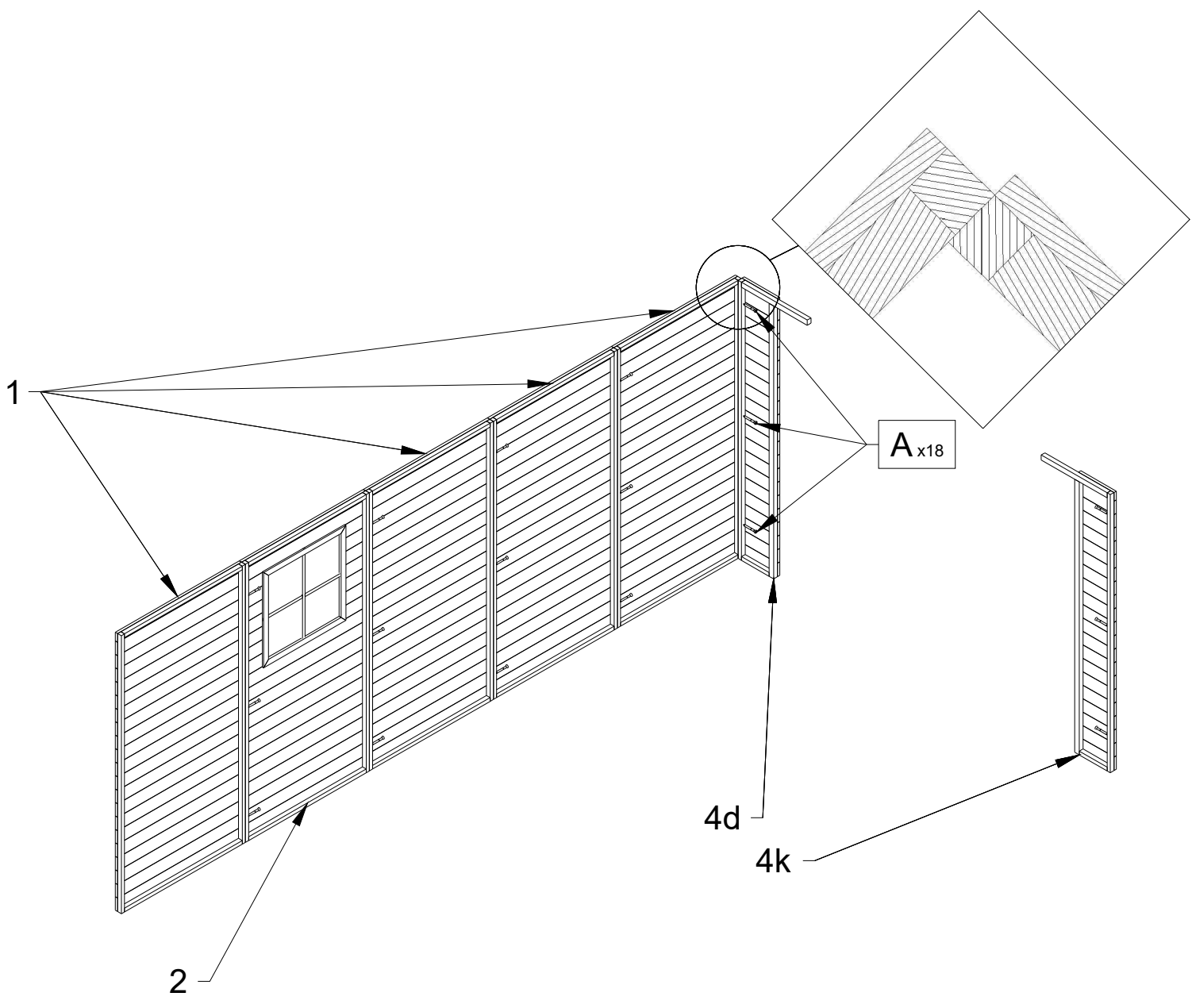

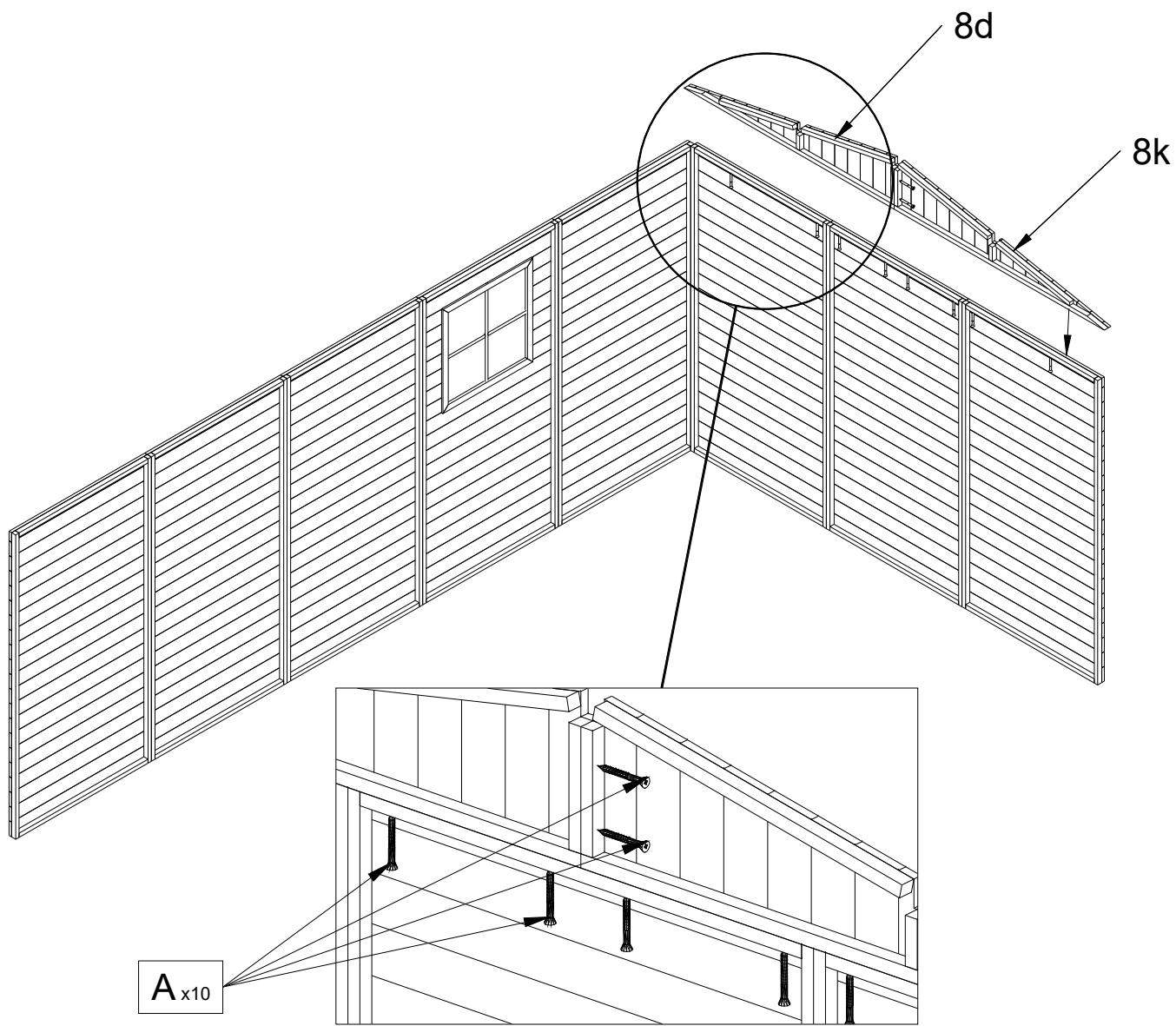

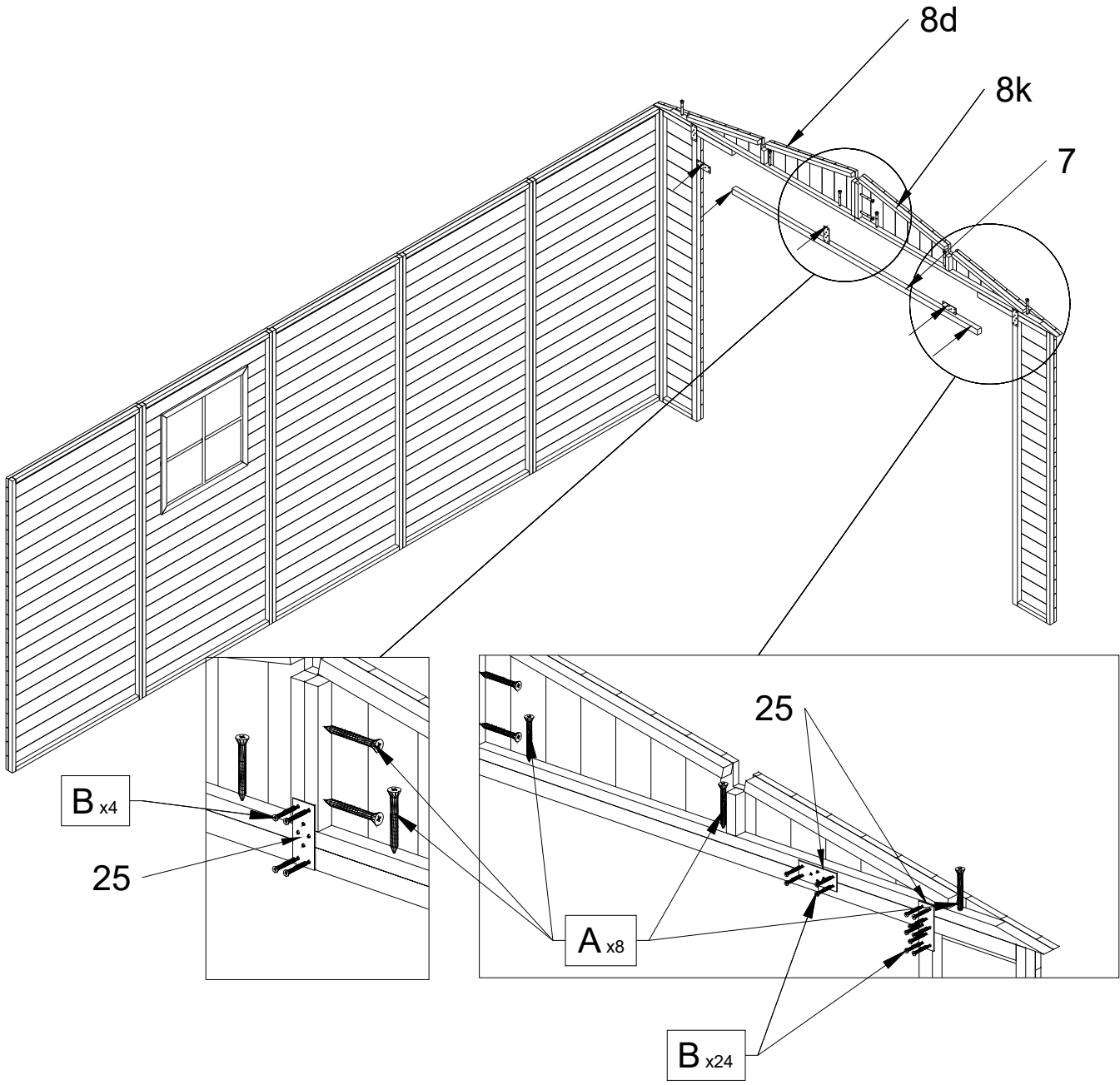

5

25

24

B x120

F x8

A x48

Ø10

10

26

B x64

110mm

C x8

30

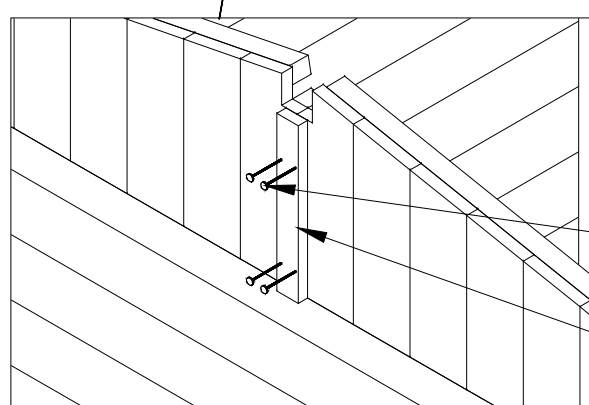
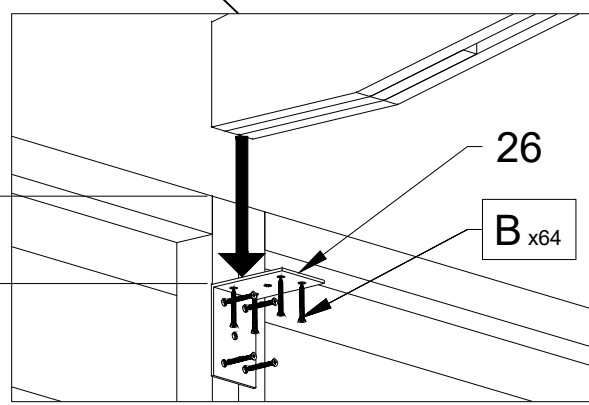
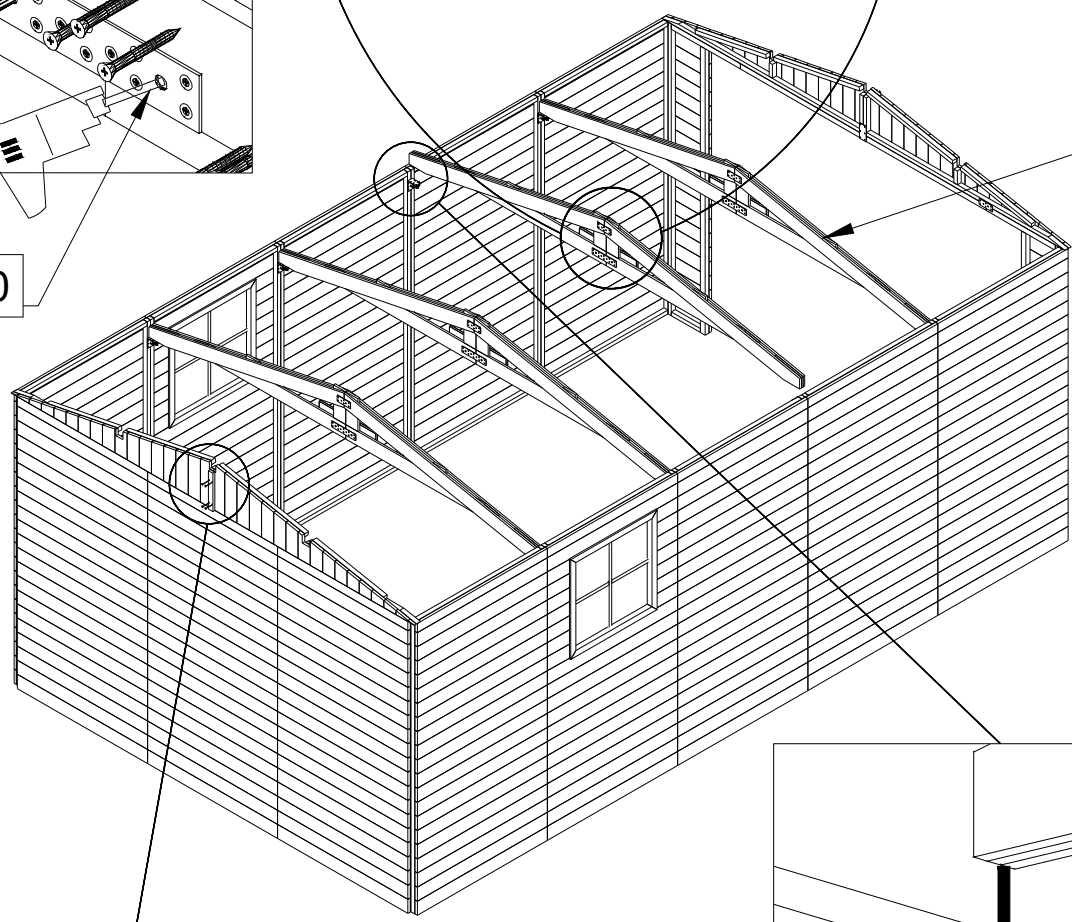
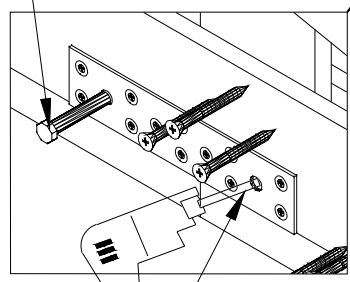
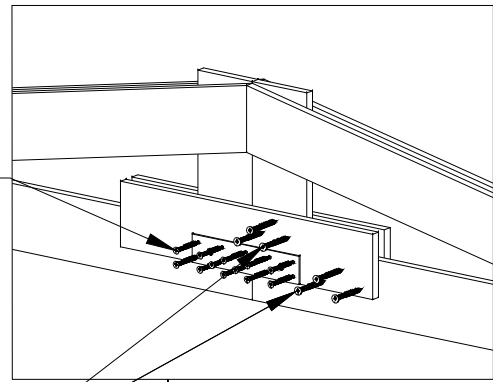
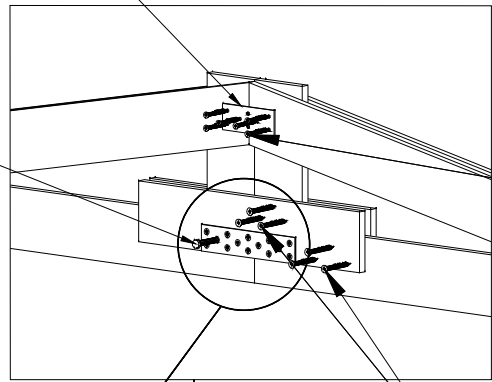

6

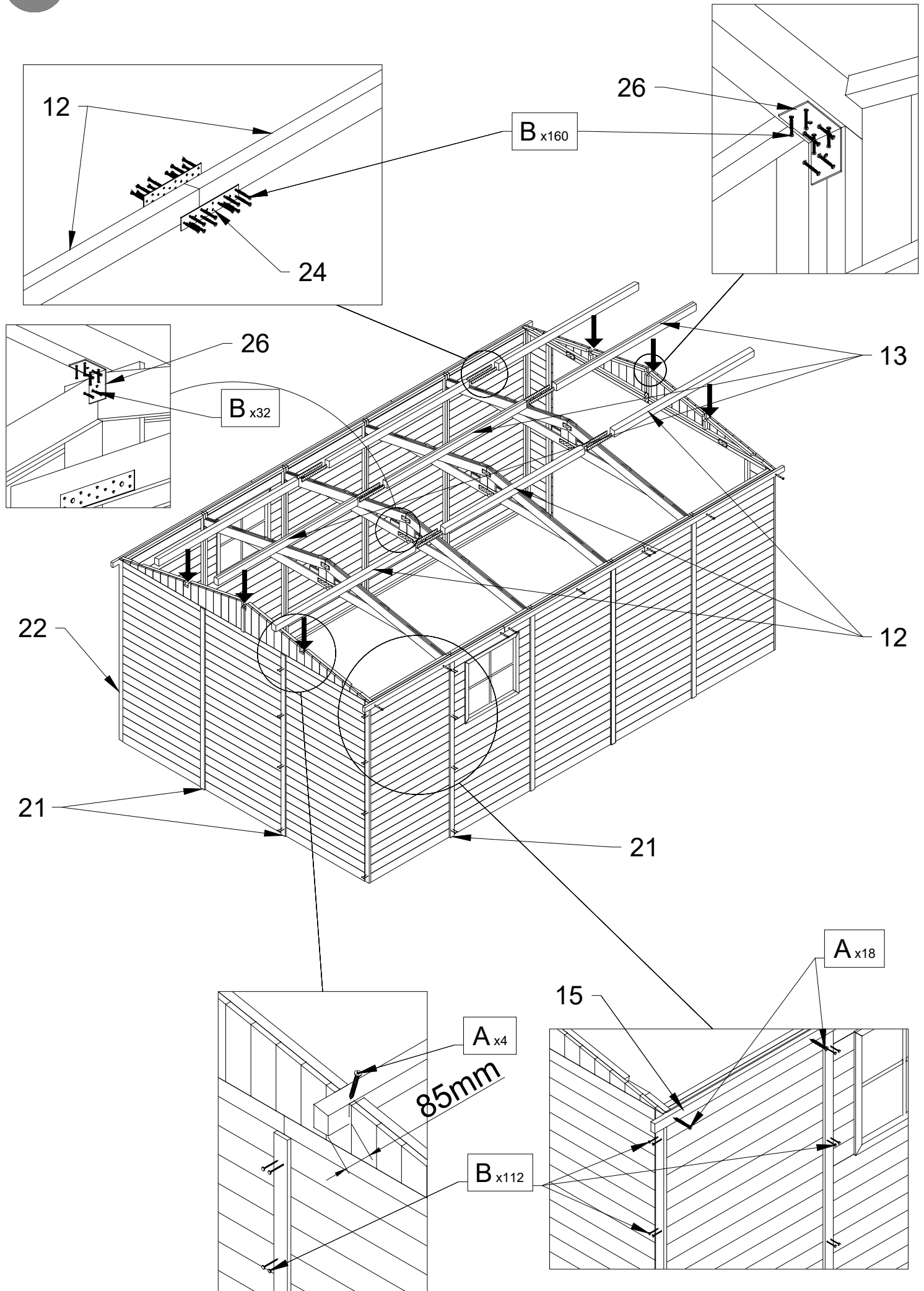

7

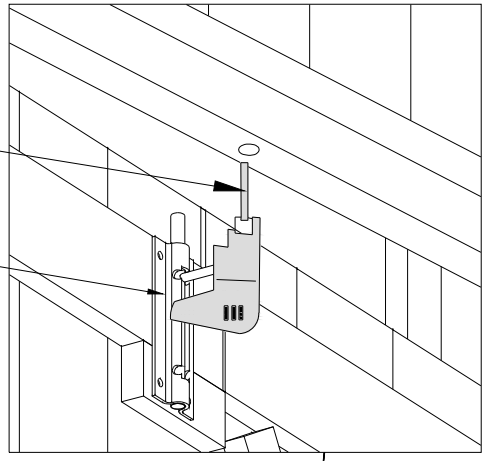
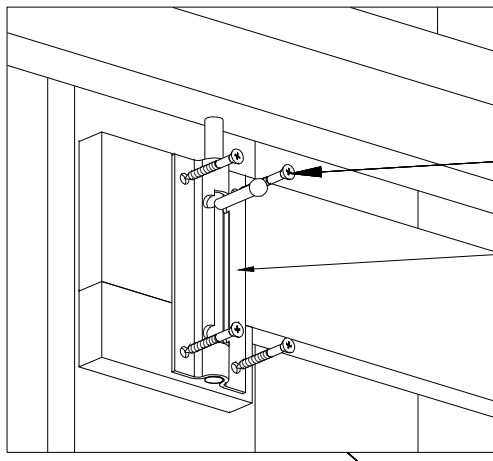

B_{x8} Ø12

29

Int.

Int.

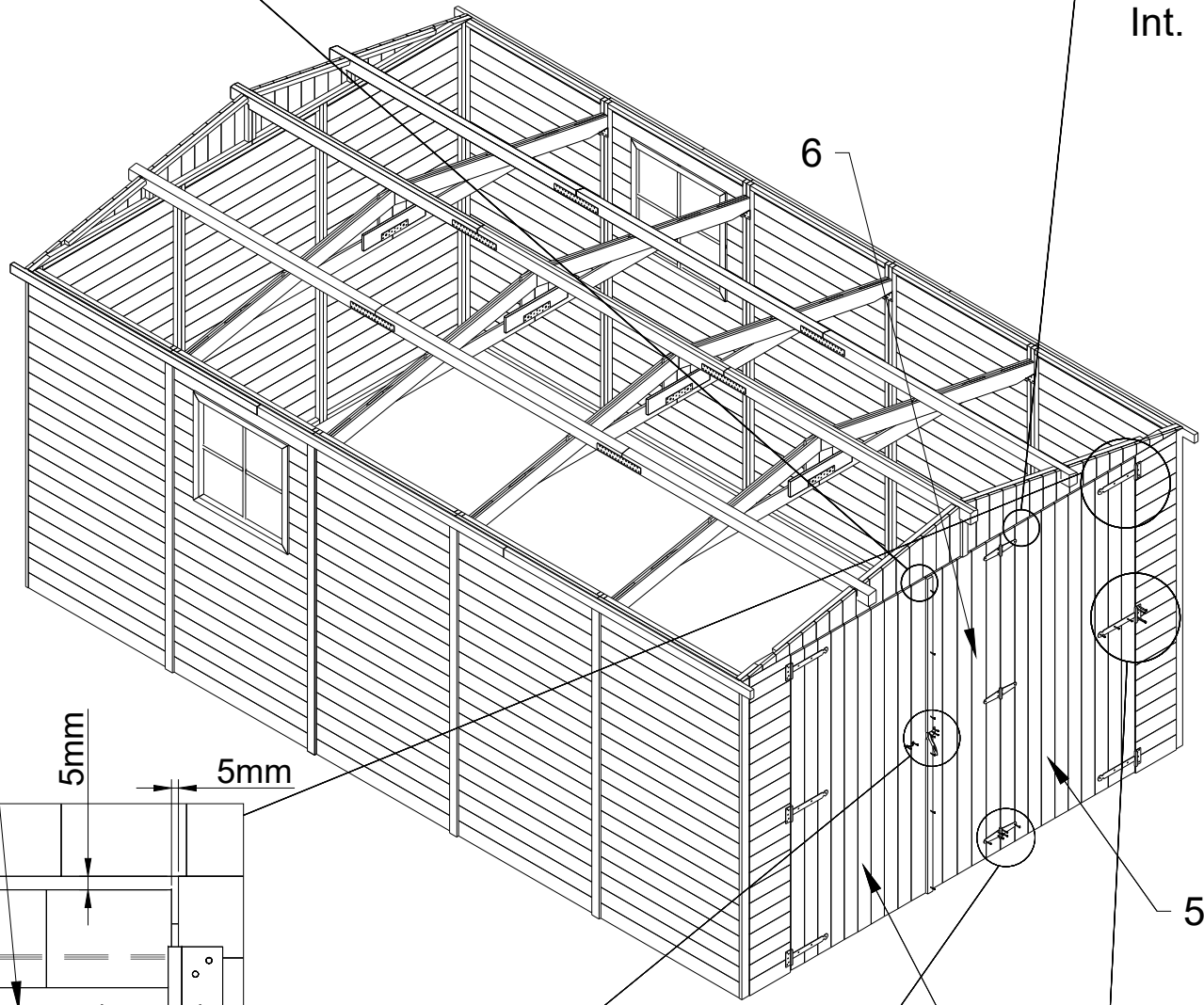

6

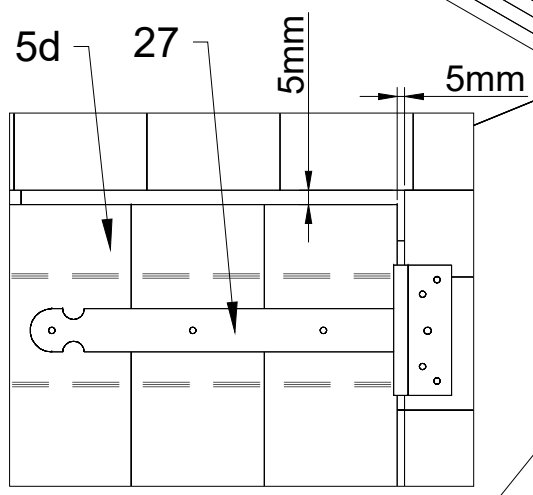

5d

27

5mm

5mm

B_{x6}

5d

5k

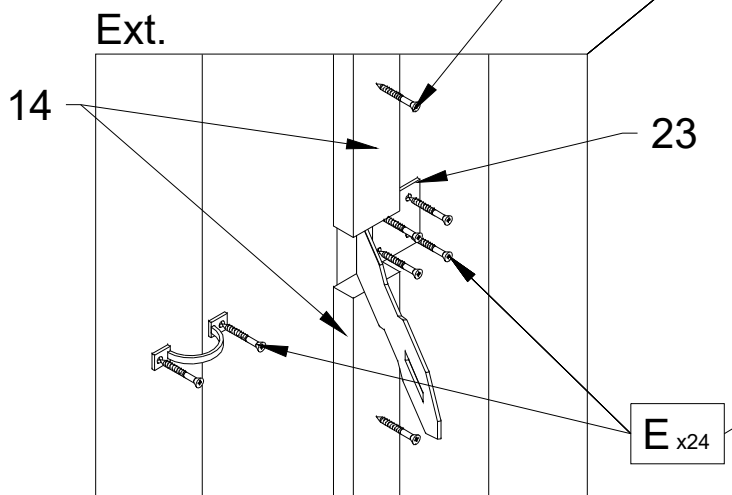

Ext.

14

23

E_{x24}

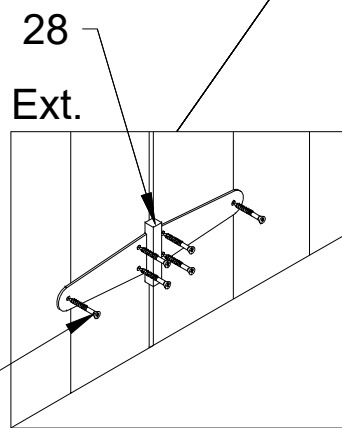

28

Ext.

Ext.

A_{x30}

27

E_{x18}

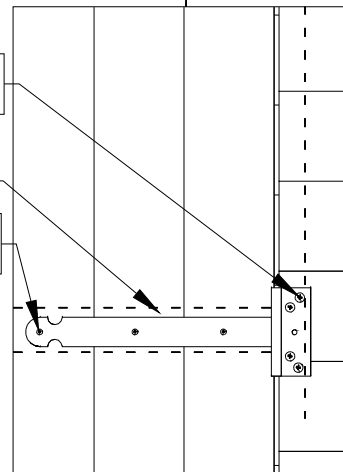

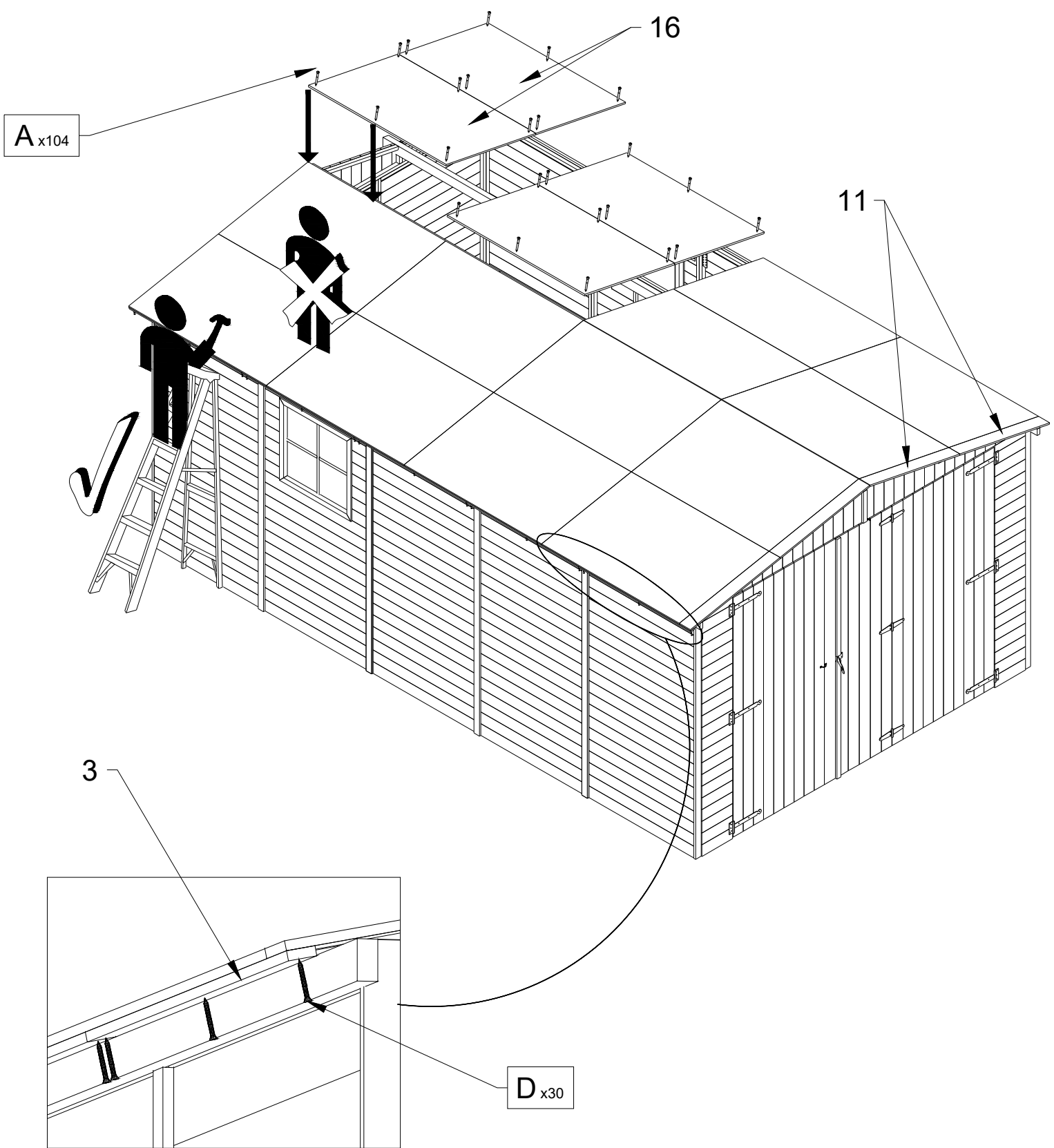

A x104

16

11

3

D x30

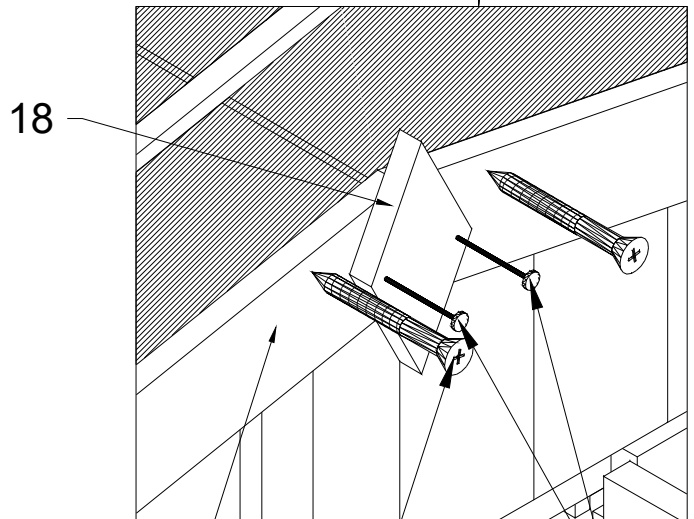
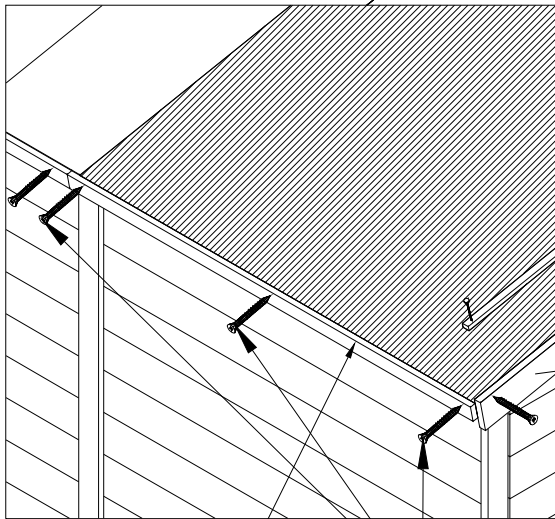
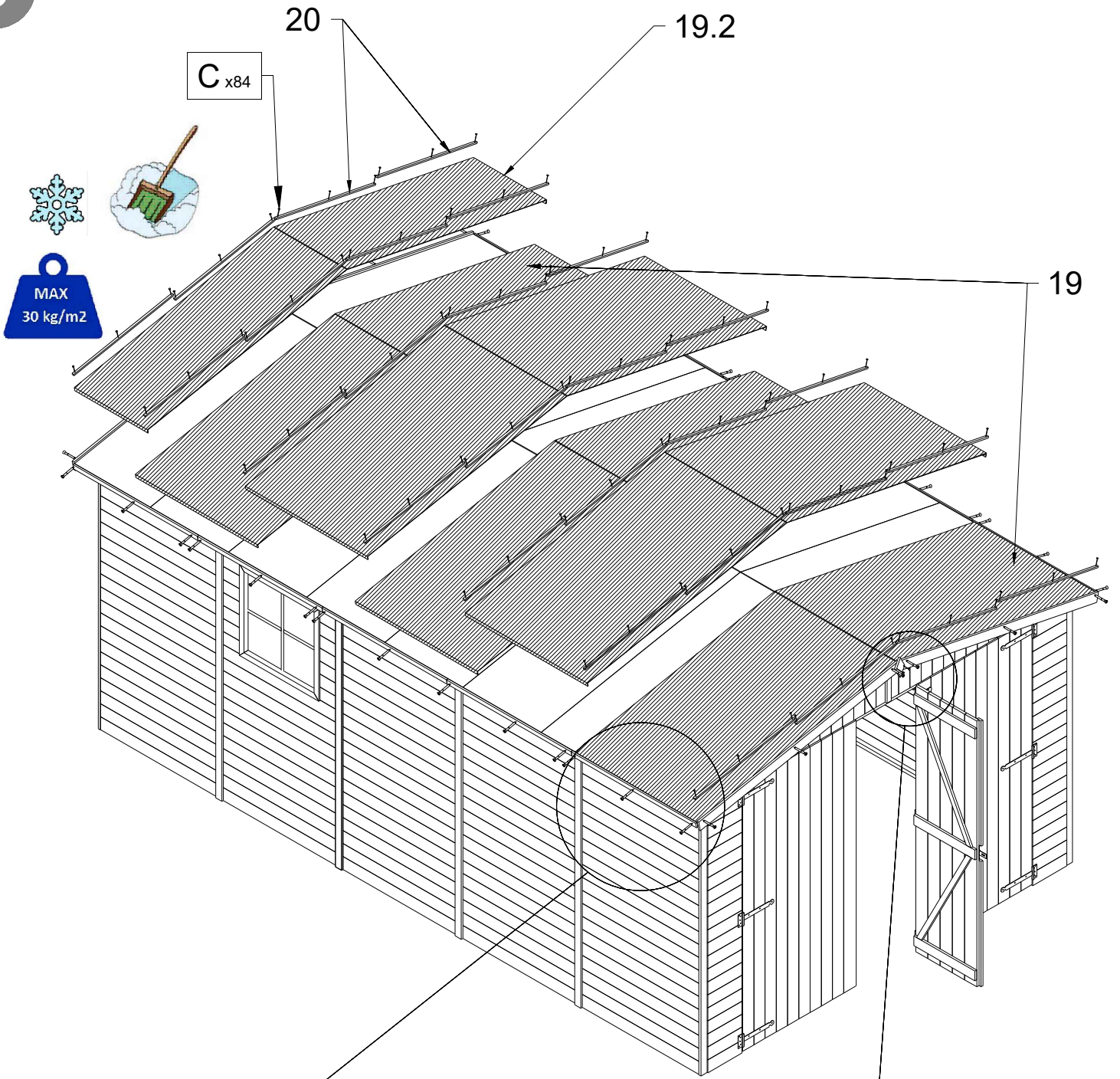

9

B x30

17

B x12

C x4